

SS 320x120x90 IP66

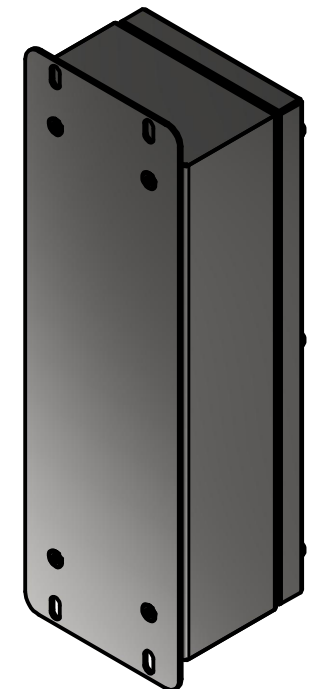
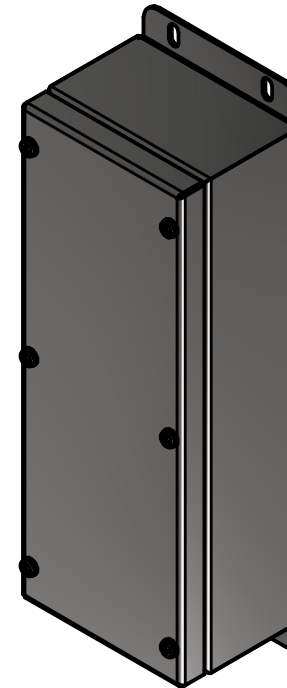
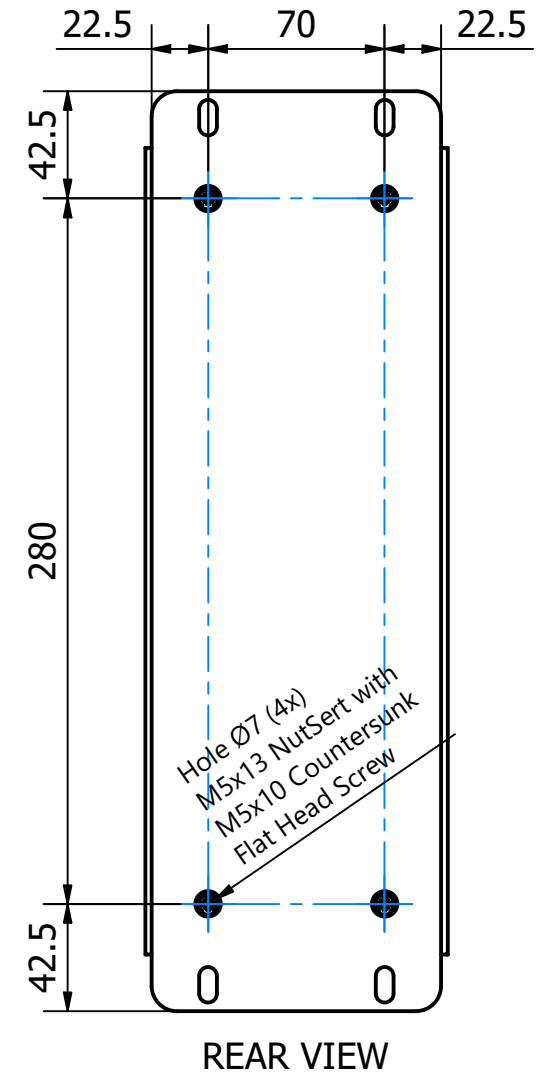
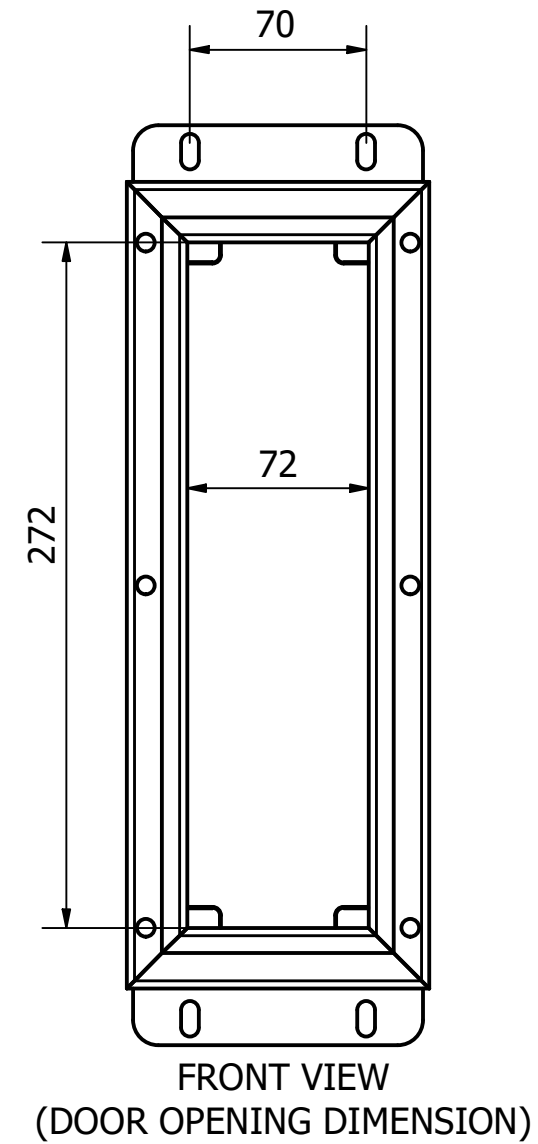
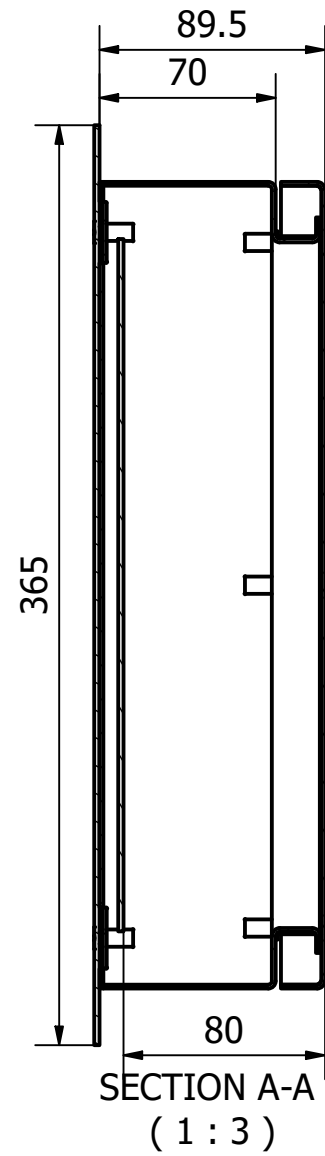
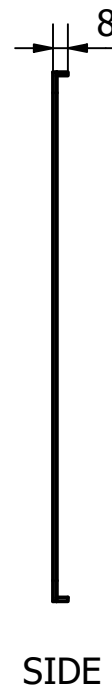
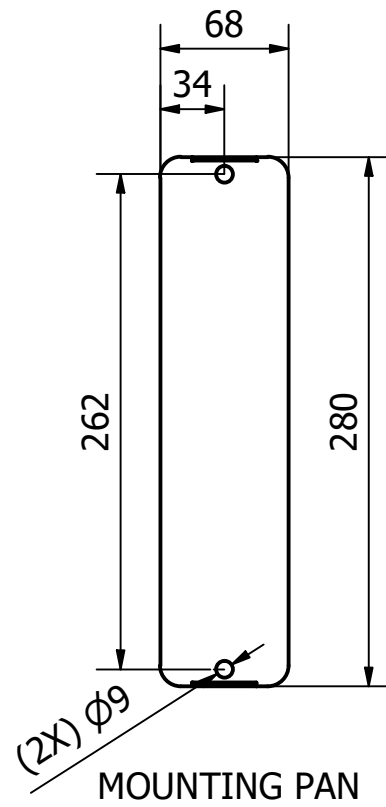
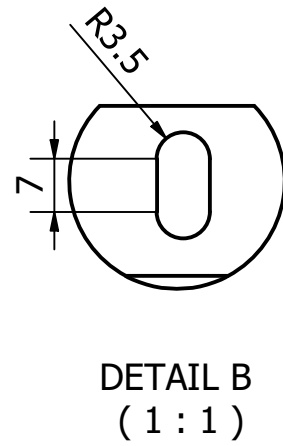
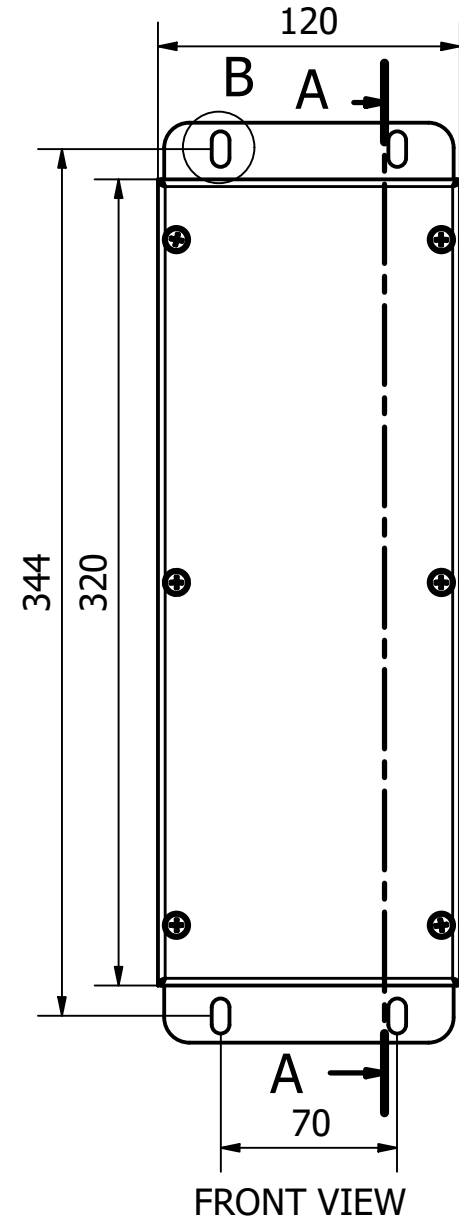

A.E. Stainless Direct
 P: 1300 533 292
 A: 4/36 Devlan St, Mansfield QLD 4122
 E: info@aestainlessdirect.com.au
 W: aestainlessdirect.com.au

ALL DIMENSIONS ARE IN MILLIMETRES.
 UNLESS OTHERWISE SPECIFIED
 TOLERANCES:
 GENERAL: ±0.5 HOLE CRS: ±0.2
 HOLE Ø: ±0.1 ANGLE: ±0.5°
 CORNER RADS = MATERIAL THICKNESS

CLIENT:
 DRAWING TITLE:
SS-PBS-B5-321290

MATERIAL:
 THICKNESS:
 FINISH:
 INGRESS PROTECTION RATING: IP66

REV	DATE	DRN	CHK	DESCRIPTION
-	-	-	-	-
-	-	-	-	-
-	-	-	-	-
-	-	-	-	-
A	2021/11/05	-	-	MOUNTING HOLES DIMS 70mm

DO NOT SCALE
 THIS DRAWING INFORMATION AND ALL TECHNICAL DATA ENCLOSED HEREIN IS THE PROPERTY OF A.E. STAINLESS DIRECT AND IS NOT TO BE USED FOR REPRODUCTION, MANUFACTURE PROCUREMENT DISCLOSURE TO ANY PARTY WITHOUT THE WRITTEN CONSENT OF A.E. STAINLESS DIRECT

SURFACE AREA N/A

DRAWN: C.H.
 30/06/2020
 CHECKED:
 DESIGN APPROVAL:
 PROJECT APPROVAL:

DRAWING NUMBER:
SS-PBS-B5-321290
 REVISION: A
 SCALE: 1:3
 SIZE: A3
 SHEET NUMBER: 1 OF 1