

SECTION B-B

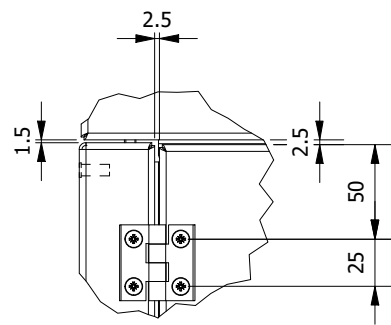

DETAIL C

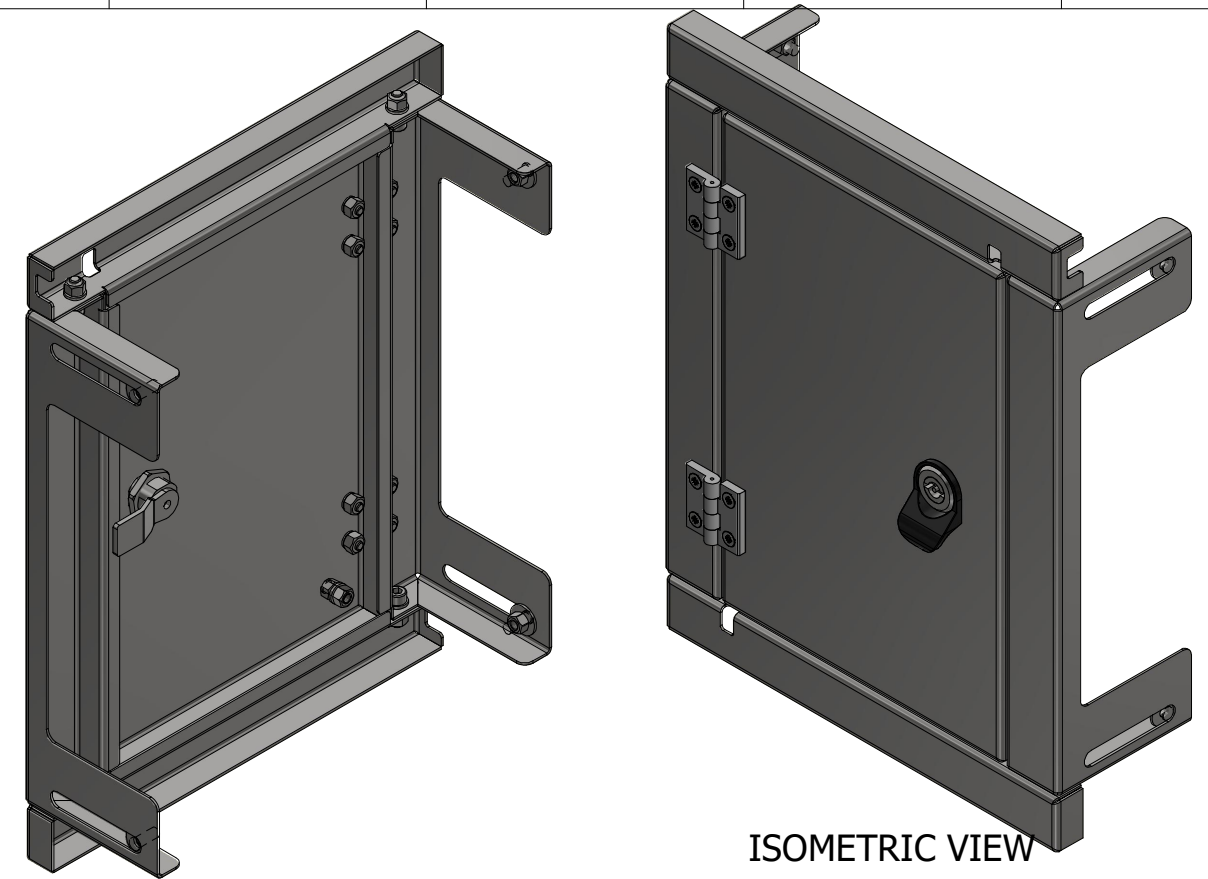

ISOMETRIC REAR VIEW

ISOMETRIC VIEW

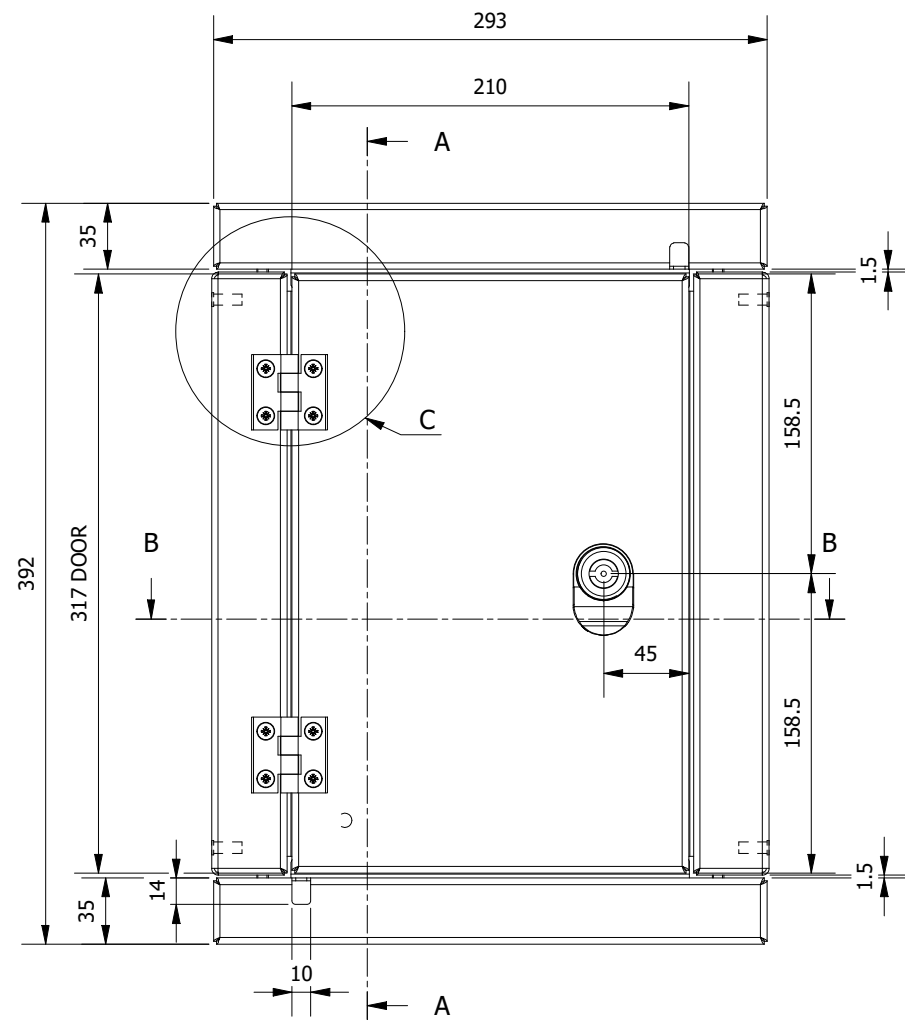

FRONT VIEW

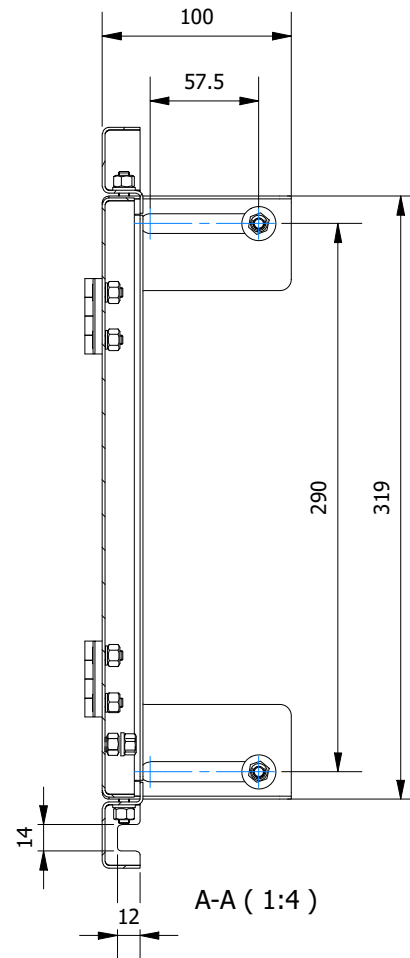

A-A (1:4)

BILL OF MATERIALS

ITEM	QTY	PART NUMBER	DESCRIPTION	MATERIAL	THICKNESS
8	2	IP3X-SS-400x300-Bottom	IP3X-Escut-Bottom	SS316N4	1.500 mm
43	1	IP3X-SS-400x300-Door	IP3X-Escut-Door	SS316N4	1.500 mm
78	1	IP3X-SS-400x300-LHS	IP3X-Escut-LHS	SS316N4	1.500 mm
113	1	IP3X-SS-400x300-RHS	IP3X-Escut-RHS	SS316N4	1.500 mm
197	2	COM10088	Hinge		
198	1	SSLock-2bit	STD 2 Bit Lock		
200	8	M5 x 16 Counter Sunk Screw	Recessed Countersunk Head Screw	Stainless Steel	
201	8	M5 Washer	M5 Washer	Stainless Steel	
202	8	M5 Hex Nyloc	M5 Hex Nyloc	Stainless Steel	
203	4	M6 Large Washer	M6 Large Washer	Stainless Steel	
204	9	M6 Hex Nyloc	M6 Hex Nyloc	Stainless Steel	
205	4	M6x16 Allen Head Screw	M6x16 Allen Head	Stainless Steel	
206	9	M6 Washer	M6 Washer	Stainless Steel	
207	1	M6 Hex Nut	M6 Hex Nut	Stainless Steel	
240	1	Earth Strap M6	M6 Earth Strap	SS316N4	
241	1	Cr-Key-2bit	2 Bit Key	SS316N4	
242	1	pt01-2	Pull Tab	ABS Plastic	

A.E. Stainless Direct
P: 1300 533 292
A: 4/36 Devlan St, Mansfield QLD 4122
E: info@aestainlessdirect.com.au
W: aestainlessdirect.com.au

ALL DIMENSIONS ARE IN MILLIMETRES.
UNLESS OTHERWISE SPECIFIED
TOLERANCES:
GENERAL: ± 0.5 HOLE CRS: ± 0.2
HOLE Ø: ± 0.1 ANGLE: ± 0.5°
CORNER RADS = MATERIAL THICKNESS

CLIENT: **AE STAINLESS DIRECT**
DRAWING TITLE: **IP3X-SS-400x300-ASSY**
MATERIAL: 316 Stainless Steel THICKNESS: 1.5mm
FINISH: -
INGRESS PROTECTION RATING: IP66

REV	DATE	DRN	CHK	DESCRIPTION
-	-	-	-	-
-	-	-	-	-
-	-	-	-	-
-	-	-	-	-
-	-	-	-	-

DO NOT SCALE
THIS DRAWING INFORMATION AND ALL TECHNICAL DATA ENCLOSED HEREIN IS THE PROPERTY OF A.E. STAINLESS DIRECT AND IS NOT TO BE USED FOR REPRODUCTION, MANUFACTURE PROCUREMENT DISCLOSURE TO ANY PARTY WITHOUT THE WRITTEN CONSENT OF A.E. STAINLESS DIRECT

FILENAME: IP3X-SS-400x300-ASSY.iam

DRAWN: C.H. 28/09/2020
CHECKED: K.K. 29/09/2020
DESIGN APPROVAL:
PROJECT APPROVAL:

DRAWING NUMBER: **IP3X-SS-400x300-ASSY**
REVISION: 0
SCALE: 1:4
SIZE: A3
SHEET NUMBER: 1 OF 1